

## Global PV Storage Insights

# Total investment cost of wall mounted battery project in Germany



## Overview

---

The project, with a total investment of more than €75 million, will benefit from the expertise of Saft, TotalEnergies' battery affiliate, which will supply the project with the latest-generation of electricity storage technology (iShift LFP —lithium-iron-phosphate— containers).

The project, with a total investment of more than €75 million, will benefit from the expertise of Saft, TotalEnergies' battery affiliate, which will supply the project with the latest-generation of electricity storage technology (iShift LFP —lithium-iron-phosphate— containers).

Paris, July 24, 2024 - TotalEnergies has taken the final investment decision for a 100 MW /200 MWh battery storage project in Dahlem, North Rhine-Westphalia. This is the first project sanctioned by TotalEnergies from the pipeline of Kyon Energy, Germany's leading battery storage system developer.

TotalEnergies plans to invest €160m (\$172.8m) in six new battery storage projects in Germany, totalling 221MW of capacity. The projects have been developed by TotalEnergies affiliate Kyon Energy. Most will utilise next-generation batteries from another TotalEnergies affiliate, Saft. Siemens.

The project will entail a total investment of over EUR 75 million (USD 81.3m), the French group said on Wednesday. The proposed battery will be located in Dahlem, in the western state of North Rhine-Westphalia, and will be equipped with lithium-iron-phosphate technology of TotalEnergies' battery.

HOUSTON, TEXAS (Editors at Energy Analytics Institute, 26.Mar.2025) — TotalEnergies, on the occasion of Patrick Pouyanné's participation in the Europe 2025 conference in Berlin, and in connection with the company's integrated development in Germany's electricity sector, revealed investment.

r battery system. The O& M cost is 2%. The report also IDs two sensitivity scenarios of battery cost projections in 2030 at \$100/kWh and \$125/kWh. In the more expensive sce ity in Schleswig-Holstein went online. The &quot;Enspire ME&quot; facility, operational after an eight-month

construction.

At the Europe 2025 conference in Berlin, TotalEnergies announced a major investment in six battery storage projects in Germany, totaling 221 MW of new capacity and a €160 million investment. These projects, developed by Kyon Energy (a TotalEnergies affiliate acquired in 2024), will feature. Who developed the new battery storage projects in Germany?

The projects were developed by TotalEnergies affiliate Kyon Energy. Credit: JeanLucIchard/Shutterstock. TotalEnergies plans to invest €160m (\$172.8m) in six new battery storage projects in Germany, totalling 221MW of capacity. The projects have been developed by TotalEnergies affiliate Kyon Energy.

How much will totalenergies invest in new battery storage projects?

Credit: JeanLucIchard/Shutterstock. TotalEnergies plans to invest €160m (\$172.8m) in six new battery storage projects in Germany, totalling 221MW of capacity. The projects have been developed by TotalEnergies affiliate Kyon Energy. Most will utilise next-generation batteries from another TotalEnergies affiliate, Saft.

Will totalenergies invest in a 100 mw/200 MWh battery storage project?

Download the Press Release (PDF) Paris, July 24, 2024 - TotalEnergies has taken the final investment decision for a 100 MW /200 MWh battery storage project in Dahlem, North Rhine-Westphalia.

When will a new battery storage project be commissioned?

The projects, with a total capacity of 221MW, are expected to be commissioned in early 2026. The projects were developed by TotalEnergies affiliate Kyon Energy. Credit: JeanLucIchard/Shutterstock. TotalEnergies plans to invest €160m (\$172.8m) in six new battery storage projects in Germany, totalling 221MW of capacity.

How much will Germany invest in battery cell research and production?

The German government will invest more than €1.5 billion (\$A2.4 billion) in battery cell research and production, starting with a €300 million (\$A488 million) grant awarded to battery company Varta. The funding is the first step in a new initiative set up under the European Union's Important Project of Common European Interest (IPCEI) program.

How much does the German government have to spend on batteries?

The German government reserved €1bn for supporting the battery cell production in the country along with an additional €500m to support the research into the next-generation and the existing batteries for electric vehicles.

## Total investment cost of wall mounted battery project in Germany



### Cost Analysis of Using a Commercial Storage Wall-Mounted Battery

A thorough cost analysis of commercial wall-mounted batteries helps decision-makers determine whether the investment will yield long-term savings and strategic value.

### The Ultimate Guide to Wall Mounted Battery: Everything You ...

Discover the benefits of wall mounted battery and how it can revolutionize your home. Find out how to choose the right battery, installation tips, and more.



### Wall-mounted Battery

A wall-mounted battery is a type of energy storage system that is designed to be mounted on a wall, saving valuable floor space and providing a convenient and accessible power source. These batteries are typically used in residential, ...

### 241212\_????????\_???\_EN

Sunwoda Photovoltaic-Storage-Charging-Changing-Inspection Integrated Solution is based on Sunwoda's core energy storage battery technology, high-power ultra-fast ...



## TotalEnergies Destines EUR160mn to Launch 6 New Battery ...

"The launch of these projects marks a major milestone in TotalEnergies' development of battery energy storage capacity in Germany, where the company has ...



## Large battery storage systems in Germany

Large battery storage systems are therefore important both for the expansion of generation plants for electricity from renewable energy sources and for stabilizing the power grid by balancing peak loads. The Market for large ...



## Cost of battery storage per mw Germany

Talking to Farmers Weekly, he said a dramatic fall in battery costs over the past year, from around & #163;700,000 to & #163;1m/MW to nearer & #163;500,000/MW (excluding grid connection of ...

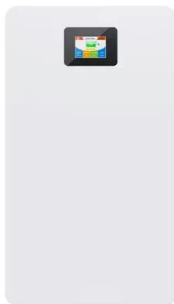

## TotalEnergies launches six new battery storage ...

TotalEnergies is launching 221 MW of new battery energy storage systems (BESS) in Germany, where the company already has 100 MW under construction. TotalEnergies' investment decision in the six BESS totals ...



## TotalEnergies to invest \$173M in battery storage in Germany

The six new battery storage projects totalling 221 megawatts will be commissioned next year and supplied by Total's German subsidiaries SAFT and Kyon Energy. ...

## Powerwall - Home Battery Storage , Tesla

Powerwall is a home battery that provides whole-home backup and protection during an outage. See how to store solar energy and sell to the grid to earn credit.

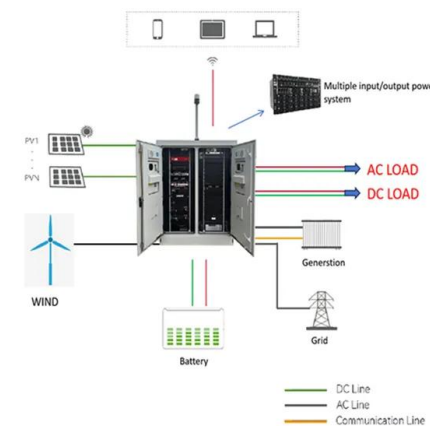

## Wall Mounted Battery Strategic Market Opportunities: Trends ...

The global wall-mounted battery market is experiencing robust growth, driven by the increasing adoption of renewable energy sources, the escalating demand for energy ...

## TotalEnergies decides to invest in 100-MW German ...

The project will entail a total investment of over EUR 75 million (USD 81.3m), the French group said on Wednesday. The proposed battery will be located in Dahlem, in the western state of North Rhine-Westphalia, and will be ...



## Wall Mount or Rack Mount? A Complete Guide to ...

Here we will talk in detail about the difference b/w wall mount and rack mount and different factors like modifications in storage systems.

## Wall-mounted Energy Storage Battery Pack Market Reporting ...

Japan Wall-mounted Energy Storage Battery Pack Market was valued at USD 0.6 Billion in 2022 and is projected to reach USD 2.

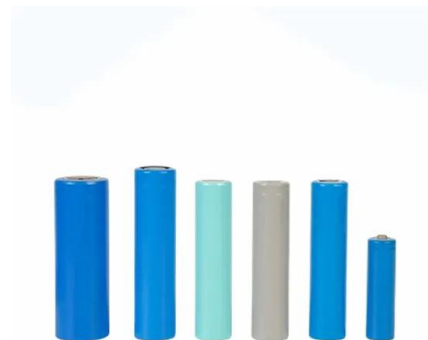

## Wall Mounted Battery

Wall Mounted Battery: Redefining Space and Power Introducing our transformative Wall Mounted Battery project - a testament to innovation that seamlessly marries cutting-edge technology with space-conscious design. At ...

## Wall Mounted Battery Market Size, Share And Opportunities

...

The challenges faced by the wall mounted battery market include high initial investment costs, concerns regarding the safe handling and disposal of battery materials, and ...

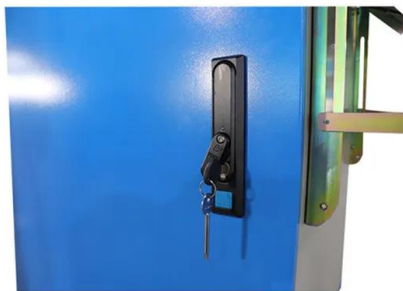

## TotalEnergies Unveils 100 MW/200 MWh Battery Storage Project in Germany

TotalEnergies has finalized its investment decision for a 100 MW/200 MWh battery storage project in Dahlem, North Rhine-Westphalia. This project is the first to be ...

## BESS in Germany 2025 and Beyond:

Battery Energy Storage Systems are positioned to play a crucial role in Germany's pursuit of a Carbon-Neutral Economy and ambitious Renewable Energy goals Introduction to BESS ...



## Cost-Effective Solar Storage for Homes in Germany: GSL 15KWH ...

Cost-Effective Solar Storage for Homes in Germany: GSL 15KWH Hybrid System On October 18th, 2022, a German homeowner decided to install the GSL ENERGY ...

## TotalEnergies Invests EUR75 Million in 100 MW Battery Storage ...

TotalEnergies invests in a 100 MW / 200 MWh battery storage project in Dahlem, Germany. Find out more about this innovative energy storage solution.



## 10 KWH 48-Volt 200ah Lifepo4 Power Reserve Power ...

Perfectly utilize the natural solar power with the help of this LINIOTECH Lifepo Reserve Power Wall Solar Battery Storage Wall Mounted.

## TotalEnergies invests in six German storage projects

TotalEnergies has taken investment decisions on six battery storage projects in Germany, with nearly EUR160m earmarked for their development.



## Integrated Power in Germany: TotalEnergies ...

The project, with a total investment of more than EUR75 million, will benefit from the expertise of Saft, TotalEnergies' battery affiliate, which will supply the project with the latest-generation of electricity storage technology (iShift ...

## TotalEnergies to launch six battery storage projects in ...

PARIS, March 26, 2025 - TotalEnergies will invest EUR 160 million in six new battery storage projects in Germany totalling 221 MW of capacity, the company said on Wednesday. The projects were developed by Kyon Energy, a ...



## ESS 48V 5kWh OZO Lithium domestic solar battery wall mounting

ESS Lithium LFP OZO Battery 48V 5kWh LiFePO4 - Wall-mounted - Wall bracket included The battery is the ideal solution for storing electricity from various sources (solar, wind, grid).

## Residential Batteries are Establishing their Role in ...

In Germany, homeowners can receive financial assistance for energy storage systems. The program covers 25% of the total investment cost. Italy has introduced the Superbonus as a tax credit program, enabling ...



## BESS in Germany 2025 and Beyond: Use Cases, ...

BESS Capacity across Germany and Projected Growth By mid-2024, Germany's total BESS capacity reached 16 GWh, which included: 13 GWh residential 1.1 GWh commercial 1.8 GWh large-scale systems Germany led ...

## TotalEnergies pursues growth in electricity by ...

TotalEnergies has announced investment decisions for six battery storage projects in connection with the company's integrated development in Germany's electricity sector. In total, these projects amount to 221 MW of ...

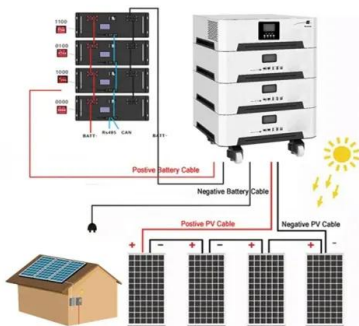

## 1.8 GWh battery storage project planned for Germany

If realized, the planned Waltrop Battery Park project will be one of Germany's largest. Construction is tipped to begin in 2026, followed by commissioning in 2028.

## Wall Mounted Energy Storage System - Dongjin Battery

Key Features Space Saving Wall mounted and space saving design. High Cycle Life 6000 cycles @80% for effectively lower total of ownership cost. Long Service Life Low maintenance battery

...

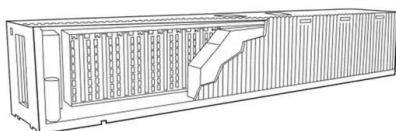

## Svolt Energy reportedly suspends 2 battery factory ...

The pack project, for which plans were announced in November 2020, was originally expected to be completed by mid-2024, with a design capacity of 24 GWh and a total investment of EUR2 billion.

## TotalEnergies decides to invest in 100-MW German ...

French energy major TotalEnergies SE (EPA:TTE) has taken the final investment decision regarding a project envisaging the installation of a 100-MW/200-MWh battery energy storage system (BESS) in Germany.

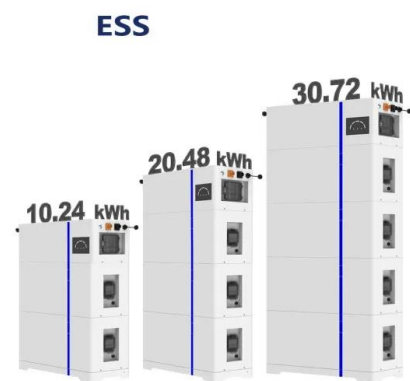

## Contact Us

---

For catalog requests, pricing, or partnerships, please visit:  
<https://naturesnursery.co.za>